

MULTI-FUNCTIONAL, ERGONOMIC
& SIMPLE TO INSTALL SOLUTIONS
TO LIVE, WORK AND MEET



INTEGRATED
SOLUTIONS FOR
FURNITURE

INCARA™

INCARA™

Incara is a range of functional, ergonomic wiring devices dedicated to any modern, flexible workspace, from office to hotel, café, airport or any other shared working environment.



WITH INCARA, USERS CAN GET TO WORK IMMEDIATELY. THEY HAVE BOTH POWER AND DATA AVAILABLE WITHIN EASY REACH FOR CONNECTING THEIR EQUIPMENT.

The range is designed with the professional installer and the end-user in mind, for simple installation, set-up and operation. Incara can be integrated into all types of furniture seamlessly, so end-users can get on with their daily lives.

Legrand, the leading manufacturer of wiring accessories, brings all its know-how, quality assurance and a wide range of functions and finishes which allow many elements of Incara to be customised upon request.

In timeless shades or coloured, Incara's attractive, modern finishes lend a touch of class to any space.

Multi-functional,
easy to install and
designed for simplicity
of operation.

INCARA



A MARK OF SUCCESS	2/3
ECO-DESIGN	4/5
CONFIGURED SOLUTIONS	6/7
CONNECTED SOLUTIONS	8/11
INSTALLATION LOCATIONS	12/13
INCARA™ DISQ 60	14/15
Recharge anywhere, at any time	
INCARA™ DISQ 80	16/17
Essential functions for mobile users	
INCARA™ DISQ 80 QI	18/19
Cordless charging anywhere	
INCARA™ DISQ'IN	20/21
Elegance and speed of installation	
INCARA™ POP-UP	22/23
Attractive appearance and easy to use	
INCARA™ MULTILINK	24/25
A configuration for every situation	
INCARA™ FLIP-UP	26/27
The premium solution for meeting rooms	
INCARA™ TOP ACCESS	28/29
The essential solution for meeting rooms	
INCARA™ ELECTR'ON	30/31
Unique design for unique environments	
INCARA™ LINK'ON	32/33
Mobile and scalable	
SELECTION GUIDE	34/37
CATALOGUE PAGES	38/48



INCARA™

A mark of success

ABOUT US

Legrand is the global specialist in electrical and digital building infrastructures. Our purpose is to improve life by transforming the spaces where people live, work and meet with electrical and digital infrastructures and connected solutions that are simple, innovative and sustainable. When you choose Legrand, you put our powerful worldwide presence and guaranteed global expertise to work for you. And you are sure to find the solutions you need among our innovative applications in new business segments.

With Legrand, you have the advantage of single logistics and distribution channels ensuring optimum lead times and mass production capability.

SOLUTIONS FOR ANY KIND OF PROJECT

The way we work is constantly changing, as are the technical requirements that modern office buildings have to fulfil: areas for people to work independently are just as important as shared offices, meeting rooms and relaxation areas. Easy and flexible access to power or data sockets whenever and wherever they are needed is a must to ensure seamless transitions between all these different ways of working. Legrand's Incara range of integrated solutions for furniture makes this possible. These flexible, stylish products are easy to install and can be integrated seamlessly into any kind of space.



LEGRAND DESIGN, A MARK OF SUCCESS

Our products are used daily by people of all ages and different cultural backgrounds all around the world. These everyday objects add a touch of quality to daily life through functionality and a seamless user experience. Design is not only about aesthetics, it is about providing solutions - that is why users and real life situations are at the heart of our process. We are always striving to meet new needs and transform our findings into smart, effective solutions that combine practicality with comfort.

SUSTAINABILITY AND QUALITY

The economic and environmental challenges we face demand an increasingly sustainable approach to designing, building and retrofitting buildings. All our products are carefully designed right down to the smallest detail to ensure their robustness and durability contributes to a sustainable world. Our designers are always mindful of the circularity of our products when designing new solutions, considering the full life cycle from manufacturing methods and materials to use and recycling. But quality is our overriding priority. The best way to help the environment is to choose a product that will last.

COLOURS, MATERIALS AND FINISHES

We take our inspiration from a wide variety of sources, including the worlds of electronics, fashion and transport, to design functional products with lasting appeal that are adapted to the environment in which they are used. Made from materials selected for their appearance and performance (impact resistant plastics, high quality aluminium), the Incara range offers three different categories of finish.

TIMELESS

Firm favourites with universal appeal

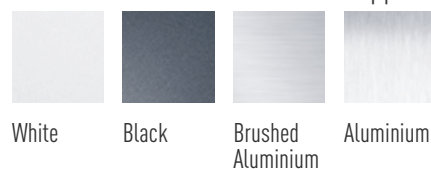

COLOURS

Available on request (selection possible in pCon software)

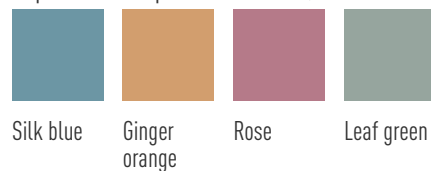

MATERIALS

High-quality materials in line with the latest trends

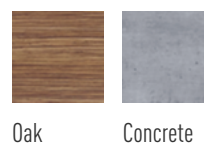

Eco-design:

An approach integrating circular economy principles



LEGRAND GROUP: FOUR MAIN AREAS OF ACTION TO IMPROVE LIVES

Legrand's corporate social responsibility (CSR) is based on four focal areas which guide and structure its commitments. Published in March 2022, the 2022-2024 CSR roadmap details the 15 priorities the Group has set itself to meet its CSR commitments and challenges, and defines the objectives to be achieved :



LEGRAND HAS BEEN AWARDED THE ECOVADIS PLATINUM MEDAL, THE HIGHEST DISTINCTION AWARDED TO THE TOP 1% OF THE BEST PERFORMING COMPANIES IN TERMS OF CSR AMONG ALL COMPANIES ASSESSED BY ECOVADIS.



PROMOTE DIVERSITY AND INCLUSION

- Gender diversity
- 'Diversity & Inclusion' labelling
- Employability of Early-in-careers
- Diversity and inclusion among suppliers

REDUCE OUR CARBON FOOTPRINT

- CO₂ emissions avoided for our customers
- Direct and indirect CO₂ emissions (scopes 1 & 2)
- Indirect CO₂ emissions (scope 3)

DEVELOP A CIRCULAR ECONOMY

- Use of recycled materials
- Phase out single-use plastic
- Environmental declarations

BE A RESPONSIBLE BUSINESS

- Customer satisfaction
- Business ethics/compliance
- Employability and skills development
- Safe workplace
- Expanded social coverage

FIND OUT MORE
ABOUT OUR CSR STRATEGY

> www.legrandgroup.com



ECO-DESIGN

Legrand's eco-design approach aims to reduce the environmental impact of its products from design to end of life, mainly through the choice of raw materials and optimised logistics.

The Incara range has been designed with cardboard packaging wherever possible to meet these environmental goals.



PRODUCT ENVIRONMENTAL PROFILE

At Legrand, we believe that it is our responsibility to inform users about the environmental impact of the Group's products. Reducing the impact of buildings on the environment starts with design choices. Informing users about the environmental impact of the products they use is therefore a top priority. The product environmental profile (PEP) is a reference tool to measure the environmental impact of electrical products.

PEPs are already available for some products.



A SUSTAINABLE OFFER

Incara solutions with integrated Mosaic functions are scalable over time. These totally modular functions can be replaced to meet new user needs as technology evolves - USB Type-C (fast charging), power rating, etc. - and repositioned in your furniture to give them a second life.

The configurable Incara connected offer can be incorporated into your workspace in a fully integrated and sustainable way, allowing you to measure and optimise your power consumption (see pages 8 to 11).



2 USB Type-C ports

USB Type-C port with 30W Power Delivery

2 USB Type-A ports

INCARA™

Configured solutions

TO MEET ALL YOUR NEEDS

The configuration and customisation options available with the Incara range mean that it can be adapted to any environment or application, meeting your most challenging requirements.

- Choose the colours to suit your furniture or customise your work spaces.
- Configure the products from among 250 Mosaic programme functions.
- Adapt the type of power supply, the length of the power cord or the dimensions of your products.

INCARA DISQ 60 / DISQ 80 / DISQ'IN / ELECTR'ON



Other colours

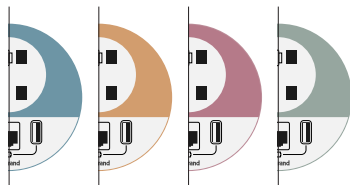

Disq'In (available on request)



Power cords

- Plug
- Wieland connector
- Length 2 m/3 m

INCARA MULTILINK / FLIP-UP / POP-UP



Lengths (maximum of 28 modules)

4 modules

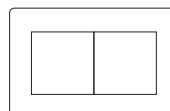

6 modules

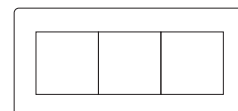

8 modules

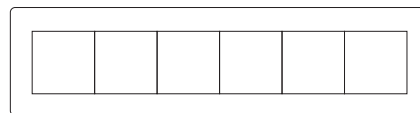
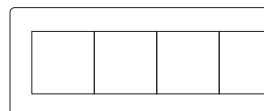

12 modules





**INCARA AVAILABLE
IN PCON SOFTWARE**



If you have a project to fit out an office or incorporate electrical accessories into office furniture and you are a professional working in the office furniture sector (architect, space planner, distributor, etc.), you can access the Legrand catalogue and configure all the Incara products easily yourself:

- Simply choose your product, the functions you require and the finish that matches your furniture.
- You will then receive the OFML files, a visual representation of your configuration and a detailed quote instantly.
- You will also find the relevant product data sheets, installation guides, brochures and videos.

KNOW MORE

Our customisation service:

- Response within 48 hours
- No minimum order
- Available within 7 to 15 working days depending on the country for the first 50 units (variable depending on the product)



A choice of functions from the Mosaic range

Choosing Mosaic means choosing a stylish, reliable, standard stocked range of products that are easy to install.

More than 250 functions in 45x45 format can be integrated into any support. All the main functions can be integrated on pCon. For other functions, please consult us.



INCARA™

Connected solutions



With connected solutions integrated into furniture and the Home + Control app, you have an innovative system to control and monitor the electrical installation in your office to **optimise comfort and energy management**. **Lighting, roller shutters and electrical office equipment** can all be controlled locally from your workstation or remotely using your smartphone and/or voice (via a voice assistant). The app also gives you the option to customise life scenes, schedule equipment operation between certain times of the day, **monitor power consumption** in detail and set alerts on a smartphone.



REMOTE CONTROL



VOICE CONTROL



EASY SCHEDULING

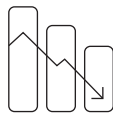

SMART ENERGY MANAGEMENT



THE HOME + CONTROL APP IS COMPLETELY FREE AND AVAILABLE FROM THE APP STORE AND GOOGLE PLAY.



PRODUCTS

Integrated connected solutions for furniture are available in preconfigured versions in the Incara Multilink and Incara On Desk ranges, equipped with Mosaic™ with Netatmo® connected functions. You can either define your desired configuration in the pCon software or contact our customisation service for more specific requirements.

* Mosaic™ with Netatmo: Legrand's Mosaic™ connected range can be controlled with the Home + Control app.



INCARA™

Connected solutions

PRINCIPLE OF A LEGRAND CONNECTED INSTALLATION

A smooth user experience, with simple solutions to install and use, making life easier.

Lights, roller shutters and power supplies for office equipment (PCs, monitors, smartphones, desk lamps, etc.) can all be controlled in one easy action from your desk. No need for individual remote controls for each different function. No matter what electrical equipment is integrated in your Legrand connected installation, you can see how much power is consumed by the whole installation or by individual products in the Home + Control app.

You can also integrate control of power outlets in life scenes to make your daily life easier. Incara connected solutions can be used to create a brand new installation or they can be integrated in an existing Legrand installation equipped with "with Netatmo" connected products.



The Legrand Cloud hosts and manages data and keeps it secure.



Wi-Fi router



The gateway acts as an interface between the Wi-Fi router and the Legrand connected products. It needs to be connected to a power outlet. Other gateway versions are also available in the "with Netatmo" wiring accessory ranges or for integration in the distribution board.



The Home + Control app is used to control offices remotely and stay informed.



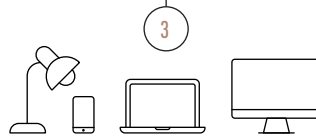
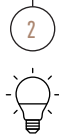

**CONFIGURATION EXAMPLE:
CONNECTED INCARA ON DESK,
INSTALLED AT THE
WORKSTATION**

- ① Wireless roller shutter and blind switch (battery powered)
- ② Wireless light switch (battery powered)
- ③ Connected 2P+E sockets and USB A+C charger (power supply for PC, monitor, smartphone, desk lamp, etc.)
- ④ Module for connected socket

KNOW MORE

Examples of add-on products*



Connected micromodule for roller shutters. Provides wireless connected capability for an electric shutter or blind.



Connected micromodule for lighting. For installation in a DCL box close to a lamp. Provides wireless connected capability for lighting.



Wireless infrared motion sensor. Allows connected electrical devices and lighting to be controlled automatically.

AND/OR

* To be ordered separately depending on functions required

Installation locations



OFFICES	Incara Disq 60 (p. 14)	Incara Disq 80 (p. 16)	Incara Disq 80 Qi (p. 18)	Incara Pop-up (p. 22)	Incara Multilink (p. 24)
COLLABORATIVE SPACES	☆	•	•	-	-
SHARED OFFICES	-	☆	•	•	•
PRIVATE OFFICES	-	•	•	☆	•
ACOUSTIC BOOTHS	•	•	-	-	☆
MEETING ROOMS	-	•	-	•	•
HOTELS					
COMMON AREAS	☆	•	•	-	•
BEDROOMS	•	☆	•	-	•
MEETING ROOMS	-	•	•	•	•
PUBLICS SPACES					
EDUCATION	•	☆	-	-	•
LIBRARY	☆	•	-	-	•
TRANSPORT	•	☆	•	•	•
CAFÉ	•	•	☆	-	-
SHOPS	☆	•	•	-	•
RESIDENTIAL					
KITCHEN	•	-	-	☆	-
HOME OFFICE	-	☆	-	•	-

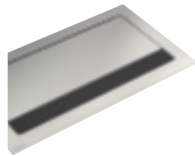
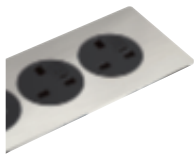

Incara Disq'In
(p. 20)

Incara Flip-up
(p. 26)

Incara Top Access
(p. 28)

Incara Link'On
(p. 32)

Incara Electr'On
(p. 30)

-	-	-	-	☆
•	-	-	-	•
•	-	•	-	•
☆	-	-	-	-
•	☆	☆	☆	-
•	-	-	-	-
•	-	-	-	•
•	☆	☆	☆	-
-	-	-	-	-
-	-	-	-	-
-	-	-	-	-
-	-	-	-	-
-	-	-	-	-
-	-	-	-	-
-	-	-	-	-

INCARA™

Disq 60

Recharge anywhere,
at any time



Disq 60

ncara Disq 60 adapts to any environment offering a power socket or a USB charger. An attractive, discreet solution that is quick to install.

MULTIPLE APPLICATIONS

Based on a standard 60 mm cut-out, it can be fixed both horizontally and vertically on any type of support (patented Legrand system), even thin ones (1 mm min). Supplied with cord equipped with a 2P+E plug or a Wieland connector.



WIDE SELECTION OF FINISHES

Understated, discreet products and finishes that blend in seamlessly with any working environment. The flush socket (patented Legrand system) looks more attractive and is easy to clean.

TIMELESS FINISHES

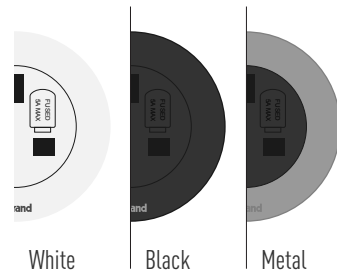

COLOURS

Available on request (selection possible in the pCon software).

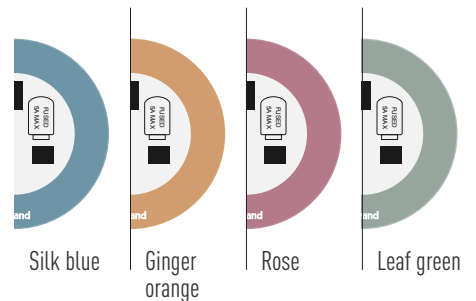

ESSENTIAL FUNCTIONS WITHIN EASY REACH

2P+E sockets or 15 W USB A+C charger to meet the connection needs of mobile users quickly and easily.

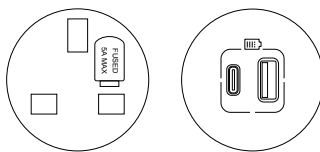

2P+E socket

USB A+C charger



INCARA™

Disq 80

Essential functions
for mobile users

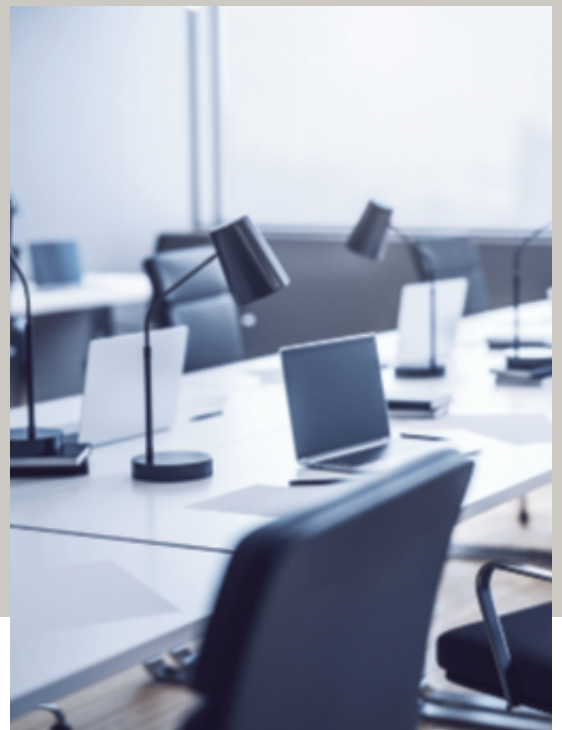

Disq 80

To meet the needs of mobile users, the Incara Disq 80 module combines essential functions in a single place.

QUICK INSTALLATION

The Incara Disq 80 module replaces the existing cable outlet in the furniture (80 mm Ø cut-out).

Supplied with cord equipped with a 2P+E plug or a Wieland connector.



MODERN DESIGN AND FINISHES

Product designed to blend in seamlessly with any office furniture. The flush socket (patented Legrand system) looks more attractive and is easy to clean.

TIMELESS FINISHES

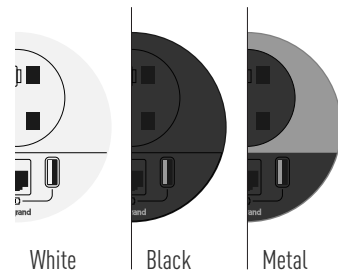

ESSENTIAL FUNCTIONS IN A COMPACT SPACE

2P+E sockets, 15 W USB A+C charger and RJ 45 Cat. 6 UTP socket or cable outlet to meet the connection needs of mobile users quickly and easily.

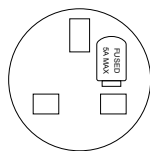

2P+E socket

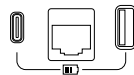

USB A+C charger and RJ 45 socket

COLOURS

Available on request (selection possible in the pCon software).

pCon

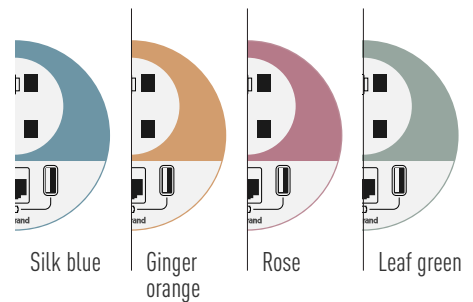

INCARA™

Disq 80 Qi

Wireless charging anywhere



Disq 80 Qi

At home, at work,
when travelling...
your smartphone needs
regular charging to get the
best performance from it.
With the Legrand Incara
Disq 80 Qi wireless power
charger, you can forget about
carrying bulky plugs around.

QUICK INSTALLATION

Extra-slim, designed for mounting horizontally on furniture, Incara Disq 80 Qi replaces the existing cable outlet in the furniture (80 mm Ø cut-out).

ELEGANT DESIGN AND FINISH

Its attractive finish blends into a meeting room table, on an office work surface, in any reception or waiting area, etc.

Can be printed with your desired logo, on request.



Aluminium | White* | Black*

KNOW MORE

- Available in a "Ready to install" kit (1 or 4 chargers + suitable power supply) or in "For customer assembly" version (25 W or 100 W power supply to be ordered separately).
- Supplied with a "Recharge at your convenience" sticker.
- 15 W - IP 44 - IK 08 conforming to WPC Qi standard, SELV Class II.



ALLOWS PARTIAL OR FULL CHARGING FOR A SMARTPHONE WITH A Qi WIRELESS RECEIVER



*Finishes only available in "For customer assembly" version.



INCARA™

AVAILABLE
ON REQUEST

Disq'In

Elegance and speed
of installation



Disq'In

ncara Disq'In blocks combine elegance, convenience and speed of installation.

They enhance your work space or your meeting room. Users are provided with the essential functions to power their mobile devices.

QUICK INSTALLATION

The innovative quick-fixing system saves a great deal of installation time (Legrand patented system). No tools required.



SLEEK, CONTEMPORARY DESIGN

Wide selection of metal plates which blend in harmoniously with existing meeting room interiors. The flush socket (patented Legrand system) looks more attractive and is easy to clean.

TIMELESS FINISHES

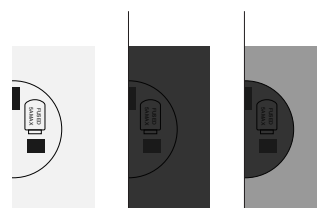

White

Black

Metal

FUNCTIONALITY AND FLEXIBILITY

Available on request in 2, 3 and 4-gang versions pre-equipped with power sockets, USB A+C charger, HDMI socket. Other versions available in preconfigured version.

4-gang

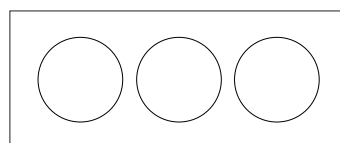
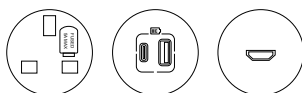
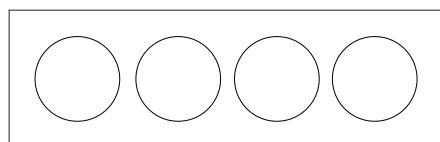

3-gang

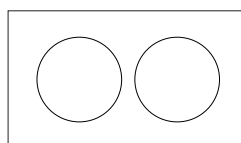

2-gang

COLOURS

Available on request (selection possible in the pCon software).

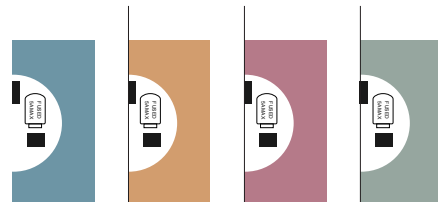

Silk Blue

Ginger orange

Rose

Leaf green

INCARA™

Pop-up

Attractive appearance
and easy to use



Pop-up

Pop-ups provide real ease of use and quick connection for mobile devices: laptops, smartphones, tablets, audio and video systems, etc. Users have a choice of both power and data connections within easy reach.

KNOW MORE

Pop-ups can take a wide range of functions available in the Mosaic range, thus complying with specific requirements, such as fast charging of portable devices. Mosaic 30 W USB Type-C Power Delivery chargers are specifically designed to charge all devices even faster! They can optimise charging by automatically selecting the most suitable voltage for the device battery.



SLEEK DESIGN

Extra-slim format to blend discreetly into the furniture. The flush-mounted part takes up little space, even allowing installation above a drawer.

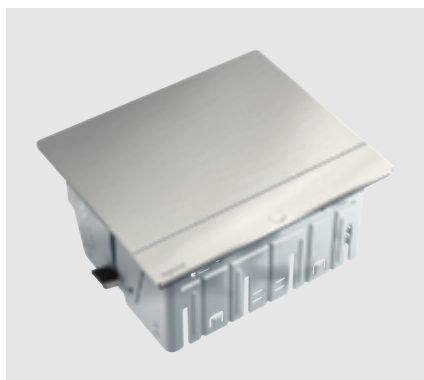

ELEGANT FINISHES

A set of finishes in harmony with both the furniture and the décor.

TIMELESS FINISHES

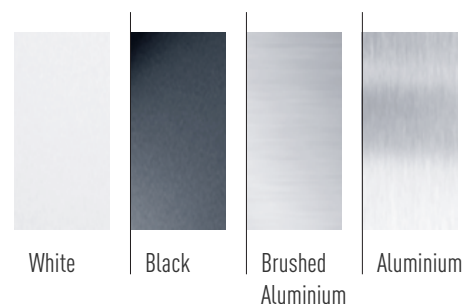

FUNCTIONALITY AND FLEXIBILITY

Available in 4, 2 x 4 and 8-module versions to be equipped or pre-equipped with power or data Mosaic functions. 4-module pop-ups are also available in a version with integral wireless power charger.



SAFETY AND EASE OF USE

Wide button and cover with damper for smooth opening (patented Legrand system). IP44 version (with closed cover) for good protection in the event of accidental contact with liquids, on pop-ups with 4 and 8 modules.



INCARA™

AVAILABLE
ON REQUEST

Multilink

A configuration
for every situation

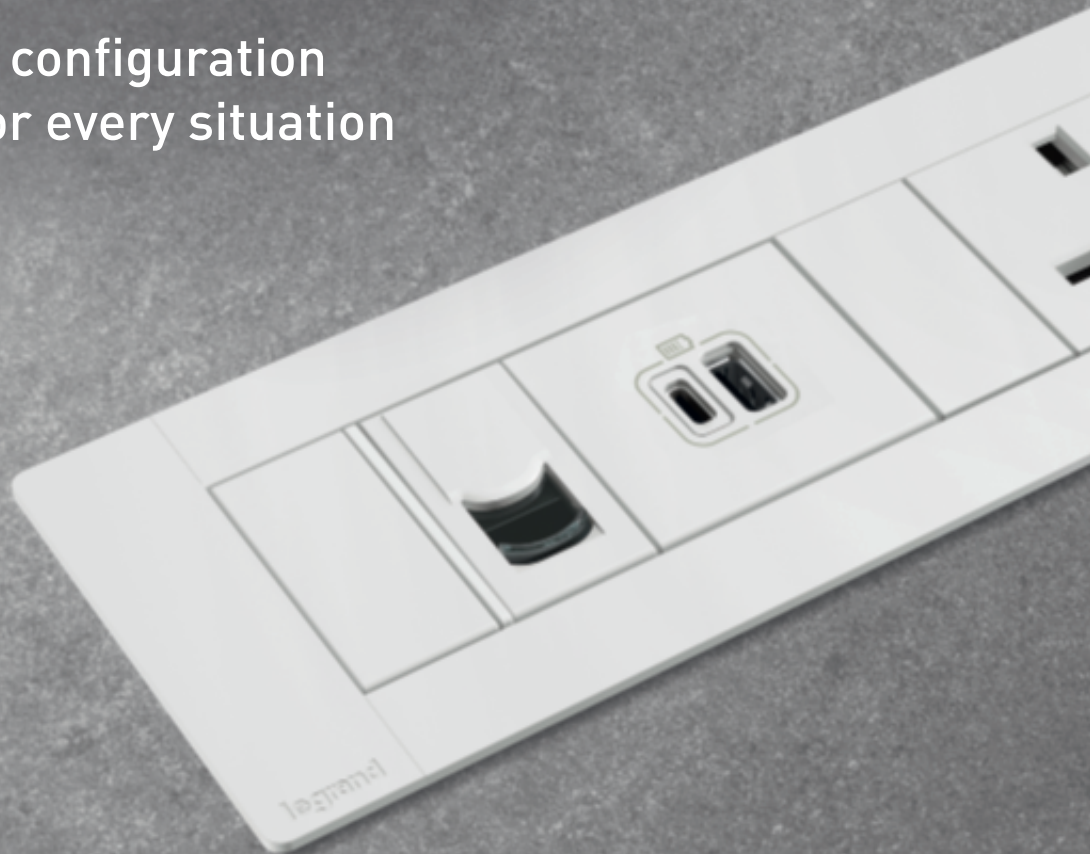

Multilink

ncara Multilink is a totally modular solution for distributing power and data, flush-mounted in the furniture or partitions.

SIMPLICITY OF INSTALLATION AND USE

Horizontal installation in furniture (min. flush-mounting depth 80 mm) or vertical installation in partitions (min. flush-mounting depth 50 mm).

AVAILABLE FINISHES

Metal, white and black for the horizontal version and white only for the vertical version.

TIMELESS FINISHES

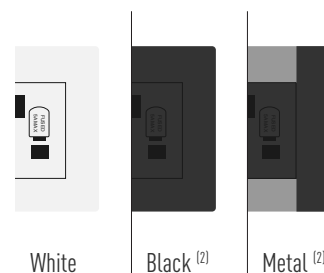

EXAMPLES OF CONFIGURATIONS ⁽¹⁾

VERSION FOR FURNITURE

4 modules

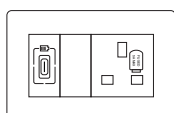

6 modules

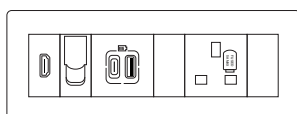
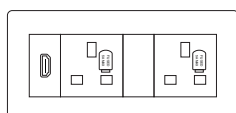

8 modules

VERSION FOR PARTITIONS

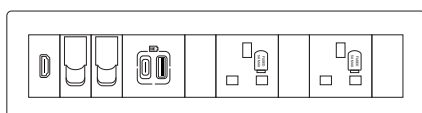

12 modules

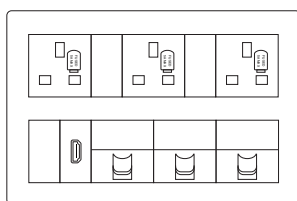

2 x 8 modules

200 FULLY MODULAR MOSAIC FUNCTIONS

Preconfigured products, available on request in version for furniture or for dry partitions. Option of choosing the length (up to 28 modules) and functions. Can take a number of functions available in the Mosaic range such as: 2P+E power sockets, RJ 45 data sockets, USB A+C chargers, HDMI sockets.

KNOW MORE

The vertical version for partitions and its reduced flush-mounting depth offers superb flexibility during installation.



(1) 1 socket = 2 modules

(2) Finishes only available in "For furniture" version.

INCARA™

Flip-up

The premium solution
for meeting rooms



regard

Flip-up

Incara Flip-up is the premium solution for meeting rooms with its elegant and crisp appearance.

Sockets fit discreetly under its cover, even with your devices plugged in.

EXCELLENT STRENGTH AND EASE OF USE

With its simple push-to-open mechanism, the cover slides inside the product and the socket unit rises up (patented Legrand system). Access to the sockets is on both sides, making it an ideal solution for meeting rooms.

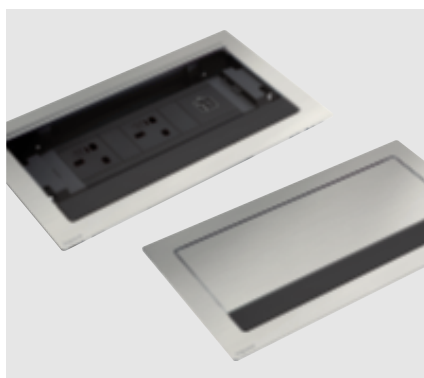

100% METAL FINISH

Metal cover, frame and cable gland plate for a sleek design which blends in harmoniously and creates a unique result.

Other finishes and equipment are available in a preconfigured version.

COLOURS

Available on request (selection possible in the pCon software).

pCon

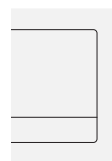

White



Black

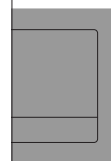

Metal

(1) 1 socket = 2 modules

The retractable system has been tested up to 18,000 operations. Incara Flip-up is available in 8 or 12 modules⁽¹⁾.

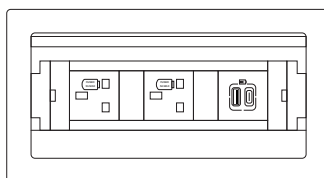

8 modules

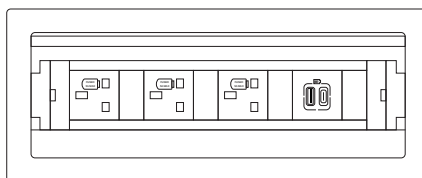

12 modules

KNOW MORE

The quick-fixing system saves a great deal of installation time (Legrand patented system). No tools required.



INCARA™

Top Access

The essential solution
for meeting rooms



Top Access

Incara Top Access enables discreet, easy storage for multi-outlet blocks and can also accommodate chargers and wires.

SIMPLICITY OF USE

With its integral basket, Incara Top Access can accommodate and conceal all electrification solutions. To ensure soft closing, the cover is fitted with a damper.

Available in 2 sizes:

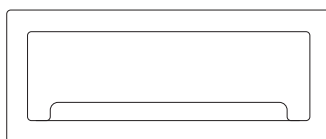

295 mm wide

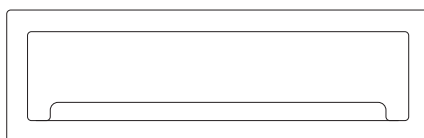

385 mm wide

AVAILABLE FINISHES

A choice of three finishes for seamless integration in workspaces.

TIMELESS FINISHES

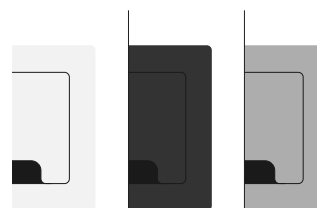

White

Black

Metal

KNOW MORE

Top Access is equipped with a fixing rail on which Legrand office modules can be locked.

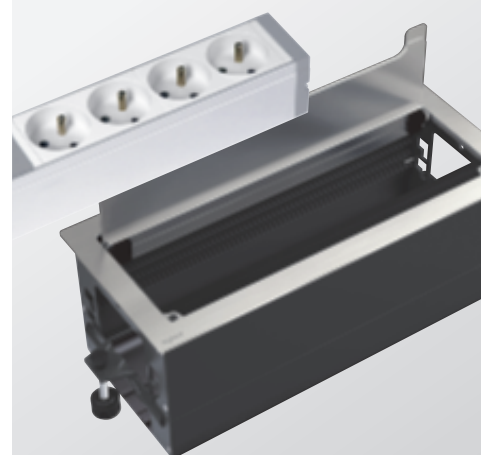

INCARA™

Electr'On

Unique design for
unique environments



reddot winner 2022

Electr'On

With its multiple finishes and accessories, Incara Electr'On will always be perfect for use in an office or workspace.

FITTED AND READY TO USE

Available in a 1-gang version, equipped with a power socket or a USB A+C charger, or a 2-gang version with two power sockets or one power socket and a USB A+C charger.



ELEGANCE AND ORIGINALITY

Incara Electr'On will surprise you with its original design and its high-quality materials such as wood and concrete, as well as the vintage style, fabric braided cable and Legrand signature label. The finishes can be easily changed over time as desired (Legrand patented system).

MATERIALS



Oak

TIMELESS FINISHES



Concrete



White



Black

COLOURS

Available on request (selection possible in the pCon software).



Silk blue



Ginger orange



Rose



Leaf green

KNOW MORE

Incara Electr'On can simply be fitted horizontally on the work surface or at an angle using the fixing accessory, for easier access to sockets.

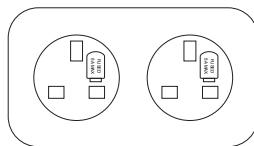
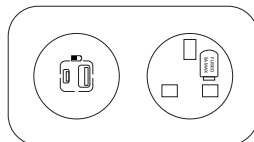
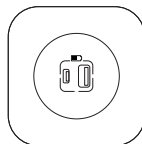
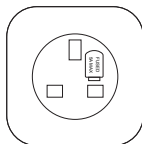

DISCOVER OUR SOLUTIONS FOR OPTIMISING FLEXIBLE CABLE MANAGEMENT.

> Go to page 37

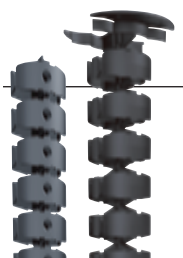

INCARA™

Link'On

Mobile and scalable



Link'On

Incara Link'On, the compact, ready-to-use, mobile solution which can supply up to 6 users with power directly on the meeting table.

SIMPLICITY OF INSTALLATION AND USE

Incara Link'On is a unique installation solution, ideally suited to the specific connection needs of mobile users in meeting rooms.

Available in several versions:

- 6 x 2P+E sockets
- 4 x 2P+E sockets and 2 USB A+C chargers, with or without an integral HDMI cable

AVAILABLE FINISH

Intense and sophisticated, black has many advantages. Black is seen as timeless, and goes with every colour. All Link'Ons are equipped with a matching cord with a braided fabric finish.

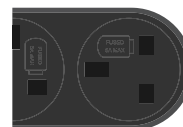

Black

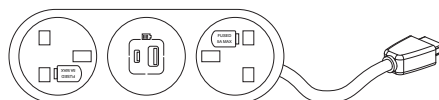
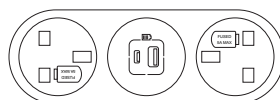
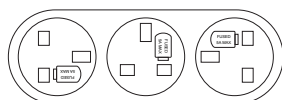

KNOW MORE

Incara Link'On units equipped with 2P+E sockets and USB A+C chargers can be joined to other Link'On extension units (1 primary + 1 secondary) to provide access to more users or adapt to the room configuration. The extension units are equipped with a 1.5 m cord with a Wieland connector.



Selection guide

Incara™ Disq 60



FUNCTION	FINISH		
	White	Black	Metal
With 2 m cord + 2P+E plug			
1 x 2P+E socket	6 550 00	6 550 01	6 550 02
1 x 15 W USB A+C charger	6 550 12	6 550 13	6 550 14
With 0.5 m cord + Wieland connector			
1 x 2P+E socket	6 550 06	6 550 07	6 550 08

Incara™ Disq 80



FUNCTION	FINISH		
	White	Black	Metal
With 2 m cord + 2P+E plug			
1 x 2P+E socket + 1 USB A+C charger + 1 x RJ 45 Cat. 6 UTP	6 549 41	6 549 42	6 549 43
With 0.5 m cord + Wieland connector			
1 x 2P+E socket + 1 USB A+C charger + 1 x RJ 45 Cat. 6 UTP socket	6 549 50	6 549 51	6 549 52
1 x 2P+E socket + 1 USB A+C charger + 1 x cable outlet	6 549 53	6 549 54	6 549 55

Incara™ Disq 80 QI



FUNCTION	POWER RATING	POWER SUPPLY	FINISH		
			White	Black	Aluminium
Kit with 1 charger	15 W	Supplied: 110 – 240 W 25 W with EU 2P plug	-	-	0 776 40L
Kit of 4 chargers	15 W	Supplied: 110 – 240 W 100 W to be wired	-	-	0 776 45L
		Supplied: 110 – 240 W 100 W with 2.5 m cord and EU 2P plug	-	-	0 776 46L
Charger for customer assembly	15 W	To be ordered separately: For 1 charger: 25 W: 0 776 38L For 4 chargers: 100 W: 0 776 39L	0 776 42L	0 776 43L	0 776 41L

Incara™ Pop Up

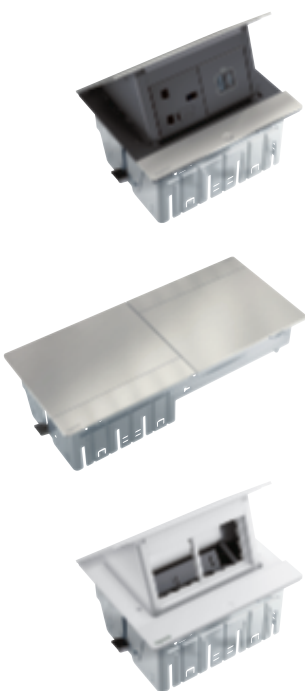

CAPACITY	FUNCTION	FINISH			
		White	Black	Aluminium	Brushed Aluminium
Ready-equipped version - products supplied with 2 m cord + 2P+E plug					
4 modules	2 x 2P+E sockets	-	-	-	6 548 33
	1 x 2P+E socket + 1 x 15 W USB A+C charger	-	-	-	6 548 30
	1 x 2P+E socket + 1 x 30 W USB C Power Delivery charger	-	-	-	6 548 39
2 x 4 modules	2 x 2P+E sockets + 1 x 15 W USB A+C charger + 2 x RJ 45 Cat. 6 UTP sockets	-	-	-	6 548 36*
Ready-equipped version - products supplied with 2 m cord + GST18i3 Wieland connector					
4 modules	2 x 2P+E sockets	-	-	-	6 548 34
	1 x 2P+E socket + 1 x 15 W USB A+C charger	-	-	-	6 548 31
2 x 4 modules	2 x 2P+E sockets + 2 x 15 W USB A+C charger	-	-	-	6 548 37*
To be equipped version					
4 modules		6 548 01	6 548 02	6 548 03	6 548 00
4 modules + wireless power charger		-	-	-	6 548 14*
4 x IP 44 modules		-	-	-	6 548 12*
8 modules		6 548 09	6 548 10	6 548 11	6 548 08*
2 x 4 modules		6 548 05*	6 548 06*	6 548 07*	6 548 04*

* Products available from January 2023

Selection guide

Incara™ Flip-up



CAPACITY	FUNCTION	FINISH	
		White	Metal
With 2 m cord + 2P+E plug			
8 modules	2 x 2P+E sockets + 1 x 15 W USB A+C charger	6 549 58	
	1 x 2P+E sockets + 1 x 15 W USB A+C charger + 1 x HDMI socket + 2 x RJ 45 Cat. 6 UTP sockets	6 549 59	
12 modules	3 x 2P+E sockets + 1 x 15 W USB A+C charger	6 549 64	
	2 x 2P+E sockets + 1 x 15 W USB A+C charger + 1 x HDMI socket + 3 x RJ 45 Cat. 6 UTP sockets	6 549 65	
With 0.5 m cord + GST 18i3 Wieland connector			
8 modules	2 x 2P+E sockets + 1 x 15 W USB A+C charger	6 549 60	
	1 x 2P+E sockets + 1 x 15 W USB A+C charger + 1 x HDMI socket + 2 x RJ 45 Cat. 6 UTP sockets	6 549 61	
12 modules	3 x 2P+E sockets + 1 x 15 W USB A+C charger	6 549 66	
	2 x 2P+E sockets + 1 x 15 W USB A+C charger + 1 x HDMI socket + 3 x RJ 45 Cat. 6 UTP sockets	6 549 67	

Incara™ Top Access (to be equipped with an office module or multi-outlet block)

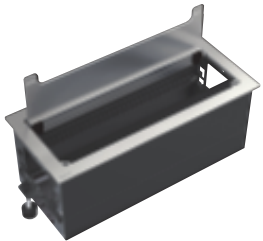

WIDTH	FINISH		
	White	Black	Metal
295 mm	6 548 71	6 548 72	6 548 70
385 mm	6 548 74	6 548 75	6 548 73

Incara™ Electr'On



FUNCTION	FINISH	CAT.NO	TRIM			
			White	Black	Oak	Concrete
"For customer assembly" version						
1 x 2P+E socket	White	6 549 12	6 549 32	6 549 33	6 549 31	6 549 30
	Black	6 549 13				
1 x USB A+C charger	White	6 549 19	6 549 32	6 549 33	6 549 31	6 549 30
	Black	6 549 21				
2 x 2P+E sockets	White	6 549 16	6 549 36	6 549 37	6 549 35	6 549 34
	Black	6 549 17				
1 x 2P+E socket + 1 x USB A+C charger	White	6 549 14	6 549 36	6 549 37	6 549 35	6 549 34
	Black	6 549 15				
Supplied in a kit						
1 x USB A+C charger	White	6 549 24	White trim supplied in the kit			
	Black	6 549 25	Black trim supplied in the kit			

Products equipped with 2.5 m cord + 2P+E plug and fixing bracket

Incara™ Link'On



FUNCTION	JOINABLE	FINISH	
		Black	
With fabric finish 2.5 m cord + 2P+E plug			
4 x 2P+E sockets + 2 x USB A+C charger	Yes, integrated Wieland connector compatible with extension Cat.No 6 548 93	6 548 92	
4 x 2P+E sockets + 2 x USB A+C chargers Integrated 2 m HDMI cable	Yes, integrated Wieland connector compatible with extension Cat.No 6 548 93	6 548 91	
With 1.5 m cord equipped with a Wieland connector			
4 x 2P+E sockets + 2 x USB A+C charger	Yes with Cat.Nos 6 548 91/92	6 548 93	

Incara™ Vertebra

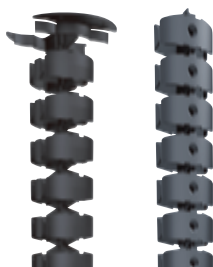

NO. OF COMPARTMENTS	LENGTH	INSTALLATION	FINISH	
			Grey	Black
2	120 cm	Horizontally or vertically	6 549 92	6 549 93
4	80 cm	Vertically	6 549 90	6 549 91

Wieland accessories

FUNCTION	LENGTH	CAT.NO
Wieland GST18 cable/2P+E socket	2 m	6 549 86
Wieland GST18 cable/2P+E socket	3 m	6 549 87
Protective box for Wieland GST18 connectors	80 cm	6 547 99

Incara™ Disq 60

for offices and collaborative spaces



Technical characteristics **see opposite**

For flush mounting in furniture in Ø60 mm cut-out
 Three methods of installation:
 - Flush mounting in the furniture (desk), 6-40 mm thickness
 - Flush mounting on a soft surface (armchair, sofa) using a dedicated accessory
 - Flush mounting on a metal panel, 1 mm thickness (locker)
 Conform to standard BS 5733

Pack	Cat.No	2P+E sockets
		250 V~ 50/60 Hz Sockets specially designed for passageways (30,000 operations) and equipped with 5 A fuse and safety shutters Conform to standard BS 1363-2
		With 0.5 m cord and GST18i3 Wieland connector
1	6 550 08	● Metal finish
1	6 550 06	○ White finish
1	6 550 07	● Black finish
		With 2 m cord and 2P+E plug
1	6 550 02	● Metal finish
1	6 550 00	○ White finish
1	6 550 01	● Black finish
		15 W USB Type-A + Type-C chargers
		Power supply: 110-240 V~ 50/60 Hz Conform to standard IEC 62368-1
		With 2 m cord and 2P+E plug
1	6 550 14	● Metal finish
1	6 550 12	○ White finish
1	6 550 13	● Black finish
		Accessory for installing in a soft surface
15	6 547 39	For strengthening the fabric cover to provide stability for the product
		Wieland accessories
		Combined Wieland GST18i3 connector/2P+E plug cord
1	6 549 86	Length 2 m
1	6 549 87	Length 3 m
		Protective casing
1	6 547 99	For Wieland GST18i3 connectors

Other configurations, socket standards and finishes available on request or via the pCon software



Incara™ Disq 60

technical characteristics

■ Dimensions (mm)

Incara™ Disq 60

Cat.Nos 6 550 00/01/02/06/07/08/12/13/14

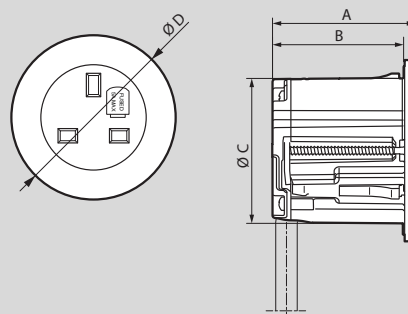

A	B	C	D
54.5	50	59	74

■ Positioning

Installing in office furniture

Drilling dimensions

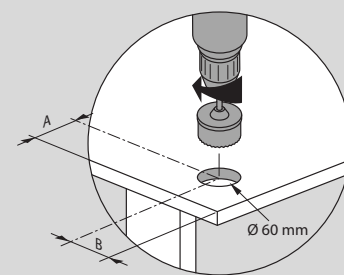
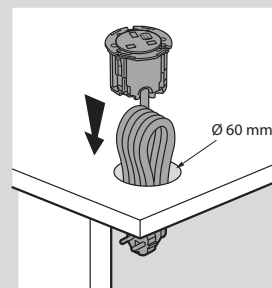

A > 95 | B > 95

Installing in metal furniture such as a locker

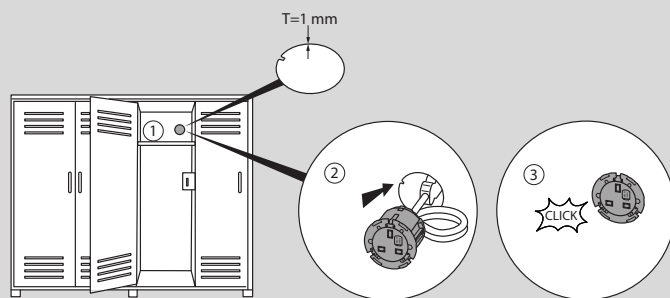

Installing in a sofa

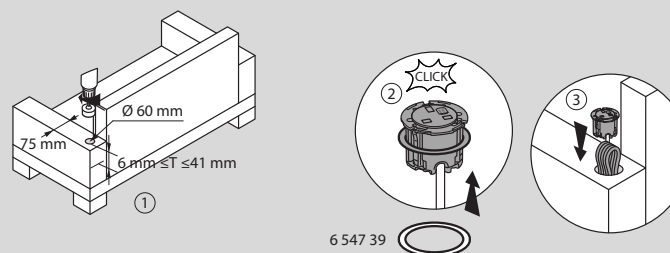

Incara™ Disq 80

for offices and collaborative spaces



Technical characteristics **see opposite**

For flush mounting in furniture, 1-40 mm thickness, in Ø79 mm cut-out
 Conform to standard BS 5733
 RJ 45 socket: feedthrough socket
 2P+E sockets conforming to standard BS 1363-2
 USB chargers conforming to standard IEC 62368-1

Pack	Cat.No	2P+E socket + 15 W USB Type-A + Type-C charger + RJ 45 cat. 6 UTP socket
1	6 549 52	● Metal finish
1	6 549 50	○ White finish
1	6 549 51	● Black finish
1	6 549 43	● Metal finish
1	6 549 41	○ White finish
1	6 549 42	● Black finish
1	6 549 55	● Metal finish
1	6 549 53	○ White finish
1	6 549 54	● Black finish
1	6 549 86	Combined Wieland GST18i3 connector/2P+E plug cord Length 2 m
1	6 549 87	Length 3 m
1	6 547 99	Protective casing For Wieland GST18i3 connectors

Other configurations, socket standards and finishes available on request or via the pCon software



Incara™ Disq 80

technical characteristics

■ Dimensions (mm)

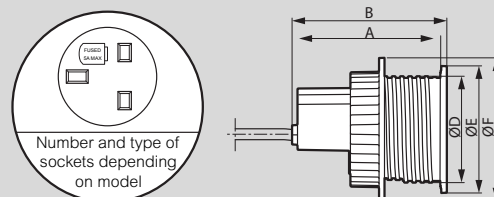

Cat.Nos	A	B	C	D	E	F
6 549 41/42/43/50/51/52	109	113	-	78	93	105
6 549 53/54/55			115			

■ Positioning

Installing in a desk

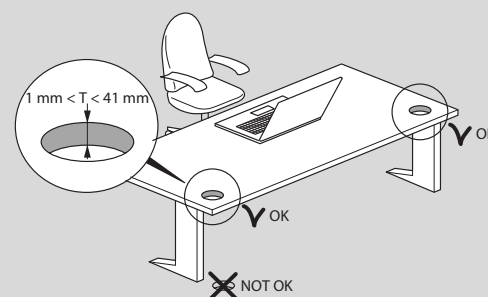

■ Drilling dimensions

Incara™ Disq 80

Cat.Nos 6 549 41/42/43/44/45/46/47/48/49/50/51/52/53/54/55

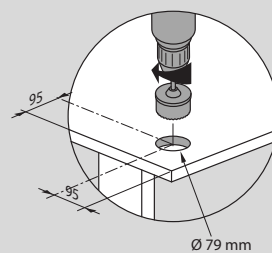

■ Insertion

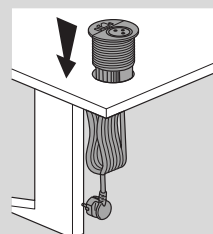

Incara™ Disq 80

for offices and collaborative spaces

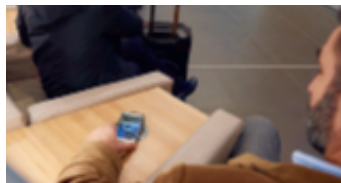

Technical characteristics [online catalogue](#)

Wireless charger for fast charging a smartphone with a Qi receiver
 Standby power consumption < 0.07W
 Energy efficiency > 85%
 Conforms to the WPC (Wireless Power Consortium) Qi standard
 Conforms to standard EN 62479 (EMF emissions)
 Conforms to ICNIRP specifications (health protection)
 Does not interfere with other wireless signals (Zigbee, DTT, GSM, 4G, etc.)

Pack	Cat.No	Ready to install wireless charger
		Specially designed for mounting horizontally on furniture in passageways or transit areas, offices or kitchen surfaces, etc. IP44 - IK08 - Class II SELV Equipped with an 8 cm ² induction antenna for fast smartphone charging 80 mm diameter cut-out using hole saw Cat.No 0 885 08, inlaid diameter 85 mm, extra-slim with thickness < 1.5 mm Charger locks under furniture with a butterfly nut WPC Qi certified Aluminium colour
1	0 776 40L	Complete kit with 1 charger for furniture Ø80 (plug) 1 x 15 W charger with 1 x 25 W power supply Power supply equipped with a 2.5 m cord 2P European plug (also available with plug conforming to US, BS, Australia or China standards; please consult us) Supplied with the following accessories: - 2.5 m RJ 45 cable - Adhesive bases and cable ties for attaching cables - Sticker Ø85-110 for identification purposes in public areas
1	0 776 45L	Complete kit with 4 chargers for furniture Ø80 (cable) 4 x 15 W chargers with 1 x 100 W power supply Power supply 2 x 2.5 mm ² for cable connection Provides several power supplies on a single line Supplied with 4 x 1 m RJ 45 cables and associated accessories Charger wired in star or series connection Plug & Play
1	0 776 46L	Complete kit with 4 chargers for furniture Ø80 (plug) 4 x 15 W chargers with 1 x 100 W power supply Power supply equipped with a 2.5 m cord 2P European plug (also available with plug conforming to US, BS, Australia or China standards; please consult us) Supplied with 4 x 1 m RJ 45 cables and associated accessories Charger wired in star or series connection Plug & Play

Pack	Cat.No	Chargers for customer assembly
		15 W wireless chargers (IP44, IK08) Single unit with power supply Cat.No 0 776 38L Multiple units with power supply/supplies Cat.No 0 776 39L Option to print a custom logo
1	0 776 42L	○ White
1	0 776 43L	● Black
1	0 776 41L	● Aluminium
		Movable power supplies for wireless chargers 1 0 776 38L 25 W power supply with 2P plug and RJ 45 cable 1 0 776 39L 100 W power supply, 2 x 2.5 mm ² , tap-off possible Supplied with 4 x 1 m RJ 45 cables Charger wired in star or series connection Plug & Play

Incara™ Pop-up

for offices and meeting rooms

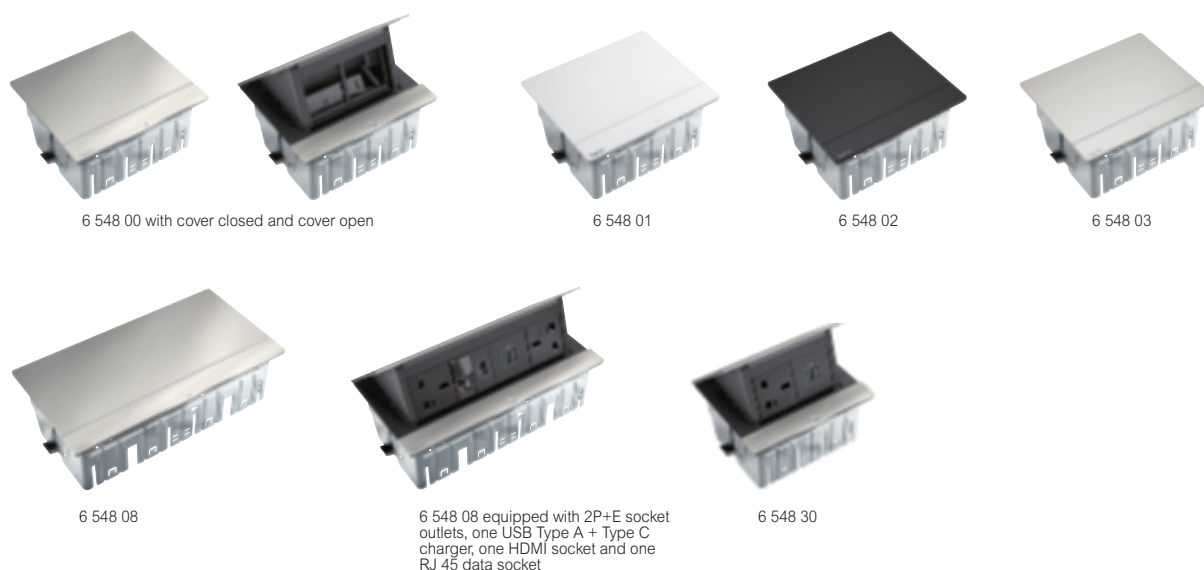

Technical characteristics p. 42

For flush mounting in furniture, compatible desktop thickness 15 to 40 mm
Metal. Protective film
Conform to standard BS 5733

Pack	Cat.No	Incara™ Pop-up to be equipped
		To be equipped with Mosaic functions
		4 modules
1	6 548 00	● Brushed Aluminium
1	6 548 01	○ White
1	6 548 02	● Black
1	6 548 03	● Aluminium
	2023	
1	6 548 12	● Brushed Aluminium (IP44)
1	6 548 14	● Brushed Aluminium with wireless charger Blue LED to indicate product is operating correctly
	2023	
		2 x 4 modules
1	6 548 04	● Brushed Aluminium
1	6 548 05	○ White
1	6 548 06	● Black
1	6 548 07	● Aluminium
		8 modules
1	6 548 08	● Brushed Aluminium
1	6 548 09	○ White
1	6 548 10	● Black
1	6 548 11	● Aluminium

Pack	Cat.No	Incara™ Pop-up pre-equipped
		2P+E sockets 250 VA equipped with 5 A fuse and safety shutters, conforming to standard BS 1363-2 USB chargers: 110/240 V~ 50/60 Hz power supply, conforming to standard IEC 62368-1
		● Brushed Aluminium
		4 modules with 2 x 2P+E sockets 2 m cord and 2P+E plug
1	6 548 33	With 2 m cord and 2P+E plug
1	6 548 34	With 2 m cord and GST18i3 Wieland connector
		4 modules with 1 x 2P+E socket + 1 x 15 W USB Type-A + Type-C charger
1	6 548 30	With 2 m cord and 2P+E plug
1	6 548 31	With 2 m cord and GST18i3 Wieland connector
		4 modules with 1 x 2P+E socket + 1 x USB Type-C 30 W Power Delivery charger
1	6 548 39	With 2 m cord and 2P+E plug
		2 x 4 modules
		Composition: 2 x 2P+E sockets + 2 x 15 W USB Type-A + Type-C charger
1	6 548 36	With 2 m cord and 2P+E plug
1	6 548 37	With 2 m cord and GST18i3 Wieland connector

Other configurations, socket standards and finishes available on request or via the pCon software

Incara™ Pop-up

technical characteristics

■ Dimensions

4 modules

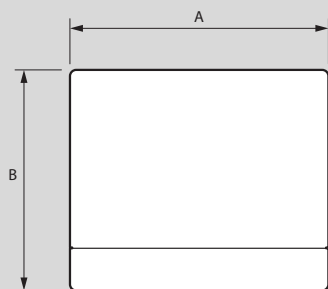

Cat.Nos	A	B
6 548 00/01/02/03/30/31/32/33/34/39	146	125

8 modules

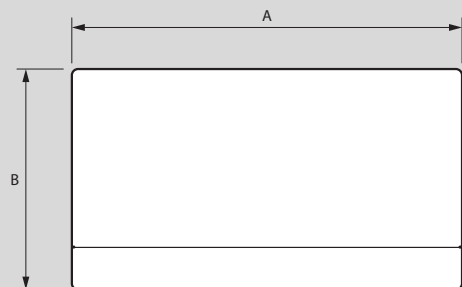

Cat.Nos	A	B
6 548 08/09/10/11	236	125

Open on the desk

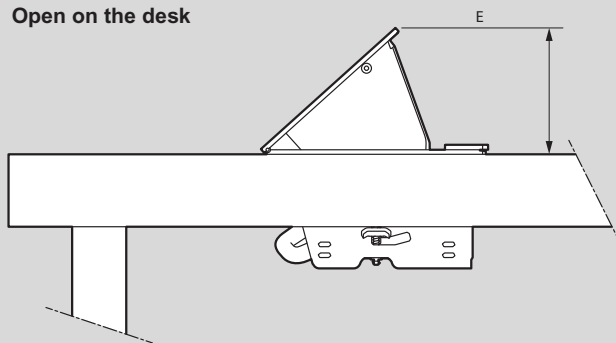

Cat.Nos	E
6 548 00/01/02/03/08/09/10/11/30/31/32/33/34/39	70

Closed on the desk

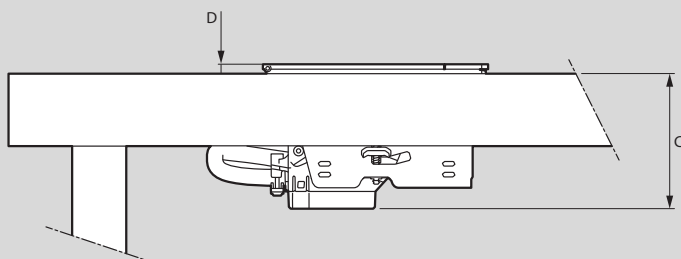

Cat.Nos	C	D
6 548 00/01/02/03/08/09/10/11/30/31/32/33/34/39	75	5.2

■ Drilling dimensions

Cut-out for corners

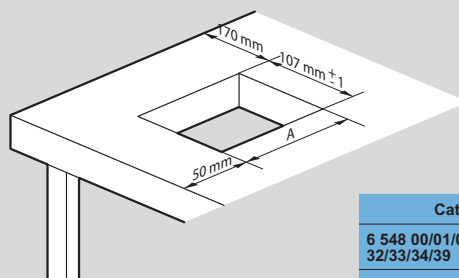

Cat.Nos	A
6 548 00/01/02/03/30/31/32/33/34/39	129 mm ± 1
6 548 08/09/10/11	219 mm ± 1



Note: For other cut-outs: see the product data sheet available online

■ Dimensions on the underside of the desk

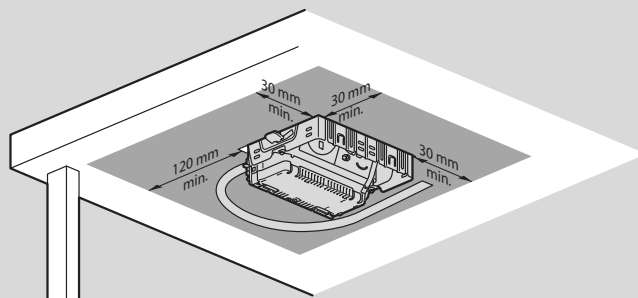

■ Insertion

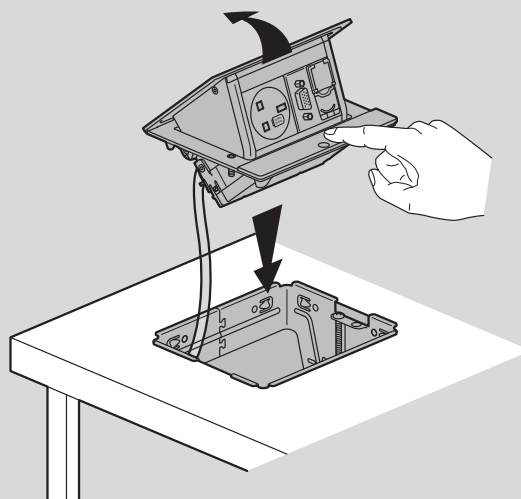

Incara™ Flip-up

for meeting rooms

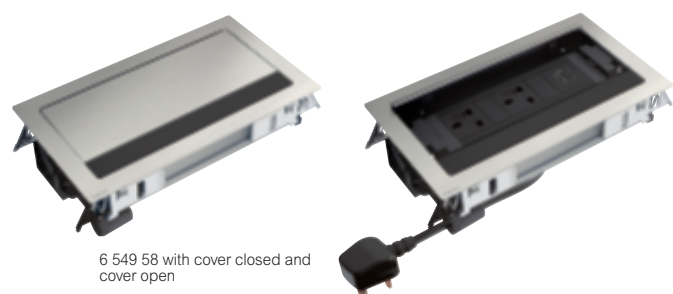

6 549 58 with cover closed and cover open

Technical characteristics p. 44

For flush mounting in furniture, compatible table thickness 15 to 40 mm
Ready to use

Max. power: 3680 W at 230 V~

Conform to standard BS 5733

2P+E sockets: 250 V~ 50/60 Hz, equipped with 5 A fuse and safety shutters, conforming to standard BS 1363-2

USB chargers: 110-240 V~ 50/60 Hz power supply, conforming to standard IEC 62368-1

Feedthrough RJ 45 and HDMI sockets

Snap-on fixing via retractable clamps

Pack	Cat.No	Incara™ Flip-up multi-outlets for flush mounting
		8 power modules
		Composition:
		- 2 x 2P+E sockets
		- 1 x 15 W USB Type-A + Type-C charger
		● Metal finish
1	6 549 58	With 2 m cord and 2P+E plug
1	6 549 60	With 0.5 m cord and GST18i3 Wieland connector
		8 power and data modules
		Composition:
		- 1 x 2P+E sockets
		- 2 x RJ 45 cat. 6 UTP feedthrough socket, 1 module
		- 1 x feedthrough HDMI socket
		- 1 x 15 W USB Type-A + Type-C charger
		● Metal finish
1	6 549 59	With 2 m cord and 2P+E plug
1	6 549 61	With 0.5 m cord and GST18i3 Wieland connector
		12 power modules
		Composition:
		- 3 x 2P+E flush sockets
		- 1 x 15 W USB Type-A + Type-C charger
		● Metal finish
1	6 549 64	With 2 m cord and 2P+E plug
1	6 549 66	With 0.5 m cord and GST18i3 Wieland connector
		12 power and data modules
		Composition:
		- 2 x 2P+E sockets
		- 3 x RJ 45 cat. 6 UTP feedthrough sockets, 1 module
		- 1 x feedthrough HDMI socket
		- 1 x 15 W USB Type-A + Type-C charger
		● Metal finish
1	6 549 65	With 2 m cord and 2P+E plug
1	6 548 67	With 2 m cord and GST18i3 Wieland connector

Incara™ Top Access

for offices and meeting rooms

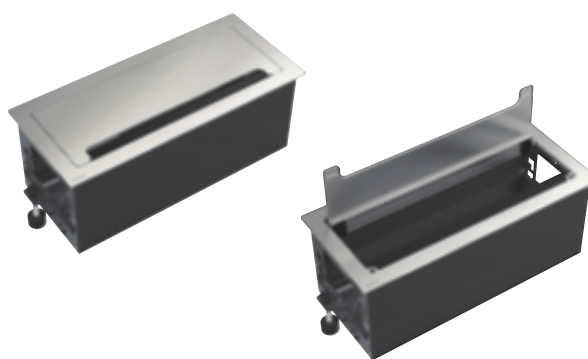

6 548 70 with cover closed and cover open

Technical characteristics p. 45

For flush mounting in furniture, compatible table thickness 10 to 40 mm
Metal

Easy storage for an office module, multi-outlet or surplus cable in the workspace

Features a dedicated fixing system for Legrand office modules

Pack	Cat.No	Incara™ Top Access
		295 mm size
1	6 548 70	● Metal
1	6 548 71	○ White
1	6 548 72	● Black
		385 mm size
1	6 548 73	● Metal
1	6 548 74	○ White
1	6 548 75	● Black

Other configurations, socket standards and finishes available on request or via the pCon software

Incara™ Flip-up

technical characteristics

■ Dimensions (mm)

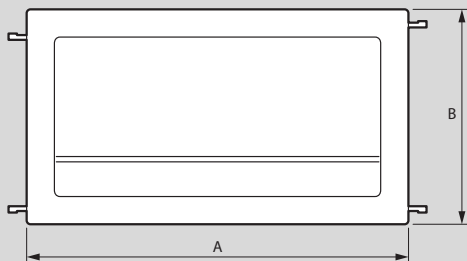
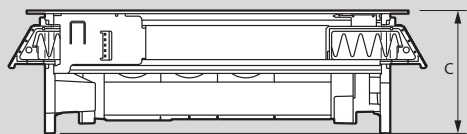

Cat.Nos	A	B	C
6 549 58/59/60/61	303	170.5	97.5
6 549 64/65/66/67	303		

■ Installing on a desktop

Drilling dimensions and maximum cut-out radius in corners

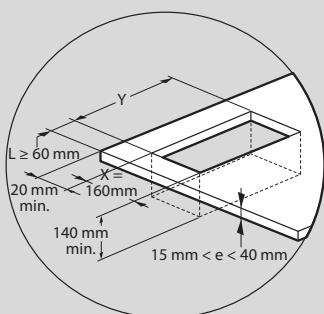

Cat.Nos	Y ± 1 mm
6 549 58/59/60/61	286
6 549 64/65/66/67	376

Note: For other cut-outs: see the product data sheet available online

■ Use

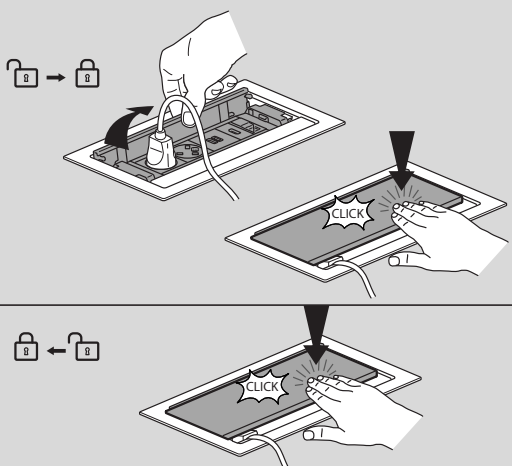

■ Insertion and fixing

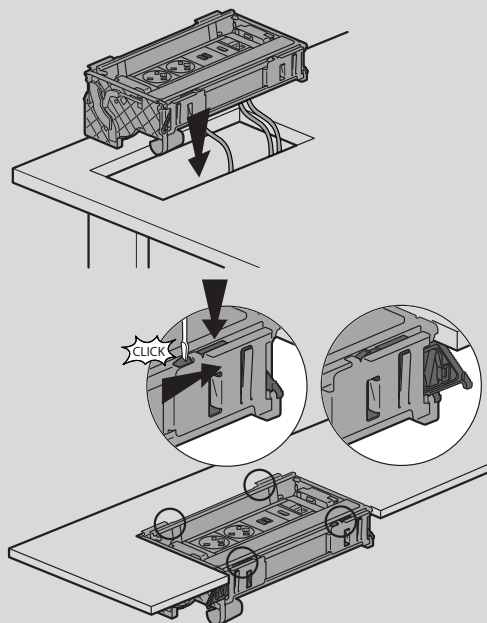

Incara™ Top Access

technical characteristics

■ Dimensions (mm)

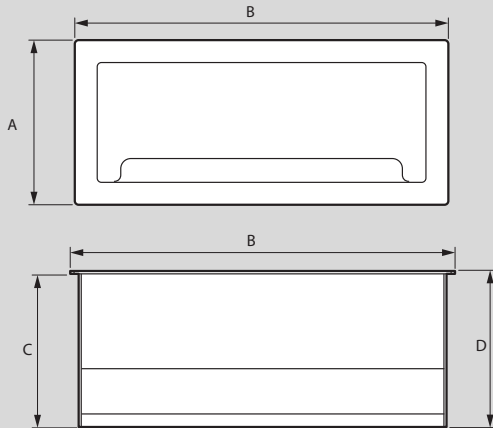

	A	B	C	D
Incara™ Top Access 295	130	295	120	122.2
Incara™ Top Access 385		385		

■ Cut-out for corners

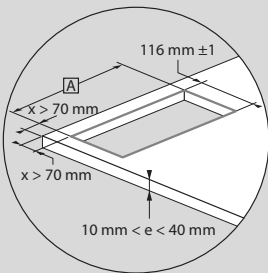

	6 548 70/71/72	6 548 73/74/75
A	284 mm ± 1	374 mm ± 1



Note: For other cut-outs: see the product data sheet available online

■ Insertion and fixing

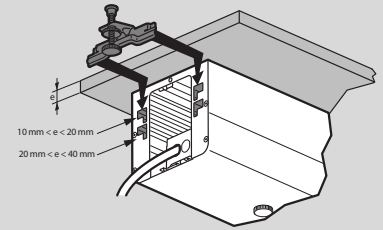
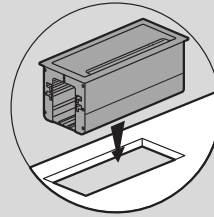

■ Installing a socket outlet unit

Standard multi-outlet

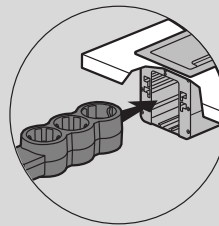

Legrand office modules

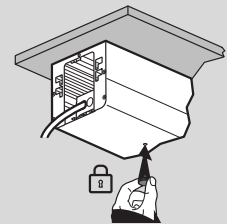
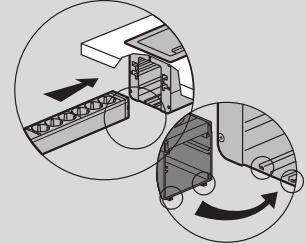

Incara™ Electr'On

for offices and collaborative spaces



Portable product for use with Zamak base and non-slip surface
 Supplied with pre-installed fixing accessory
 Conform to standard BS 5733

Pack Cat.No 15 W USB Type-A + Type-C charger kits

		With integrated finish and 2.5 m braided fabric power cord 110-240 V~ 50/60 Hz power supply Conform to standard IEC 62368-1
1	6 549 24	1-gang ○ White
1	6 549 25	● Black

Pack Cat.No 15 W USB Type-A + Type-C chargers

		With 2.5 m braided fabric power cord 110-240 V~ 50/60 Hz power supply Conform to standard IEC 62368-1
1	6 549 19	1-gang Base to be equipped with a 1-gang finish Cat.Nos 6 549 30/31/32/33 ○ White
1	6 549 21	● Black

Pack Cat.No 2P+E sockets

		Sockets specially designed for passageways (30,000 operations), equipped with 5 A fuse and safety shutters With 2.5 m braided fabric power cord 250 V~ 50/60 Hz Conform to standard BS 1363-2
1	6 549 12	1-gang Base to be equipped with a 1-gang finish Cat.Nos 6 549 30/31/32/33 ○ White
1	6 549 13	● Black
1	6 549 16	2-gang Base to be equipped with a 2-gang finish Cat.Nos 6 549 34/35/36/37 ○ White
1	6 549 17	● Black

Pack Cat.No 2P+E sockets + 15 W USB Type-A + Type-C chargers

		Sockets specially designed for passageways (30,000 operations) and equipped with 5 A fuse and safety shutters With 2.5 m braided fabric power cord 2P+E sockets: 250 V~ 50/60 Hz Conform to standard BS 1363-2 USB chargers: 110-240 V~ 50/60 Hz power supply Conform to standard IEC 62368-1
1	6 549 14	2-gang Base to be equipped with a 2-gang finish Cat.Nos 6 549 34/35/36/37 ○ White
1	6 549 15	● Black

Pack Cat.No Finishes

		Locked in place by a 1/4 turn clip with built-in anti-theft system
1	6 549 31	1-gang ● Oak
1	6 549 30	● Concrete
1	6 549 32	○ White plastic
1	6 549 33	● Black plastic
1	6 549 35	2-gang ● Oak
1	6 549 34	● Concrete
1	6 549 36	○ White plastic
1	6 549 37	● Black plastic



Other configurations and other finishes available on request or via the pCon software

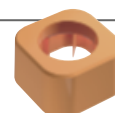

Incara™ Link'On

for meeting rooms



6 548 92

Portable, ready-to-use multi-outlet extensions for meeting rooms
 For connecting multimedia devices as close to the user as possible without having to drill into furniture
 Conform to standard BS 5733
 Max. power: 3680 W at 230 V~ per circuit
 2P+E sockets: 250 V~ 50/60 Hz, equipped with 5 A fuse and safety shutters, conforming to standard BS 1363-2
 USB chargers: 110-240 V~ 50/60 Hz power supply, conforming to standard IEC 62368-1

Pack	Cat.No	Extendable Incara™ Link'On outlet unit
1	6 548 91	With 2.5 m power cord and 2P+E plug Can be used together with fuse and extension Cat.No 6 548 93 for more users ● Black Composition: - 4 x 2P+E sockets - 2 x 15 W USB Type-A + Type-C chargers - 1 x 2 m HDMI cable - Integrated Wieland GST18i3 connector for connecting extension Cat.No 6 548 93
1	6 548 92	● Black Composition: - 4 x 2P+E sockets - 2 x 15 W USB Type-A + Type-C chargers - Integrated Wieland GST18i3 connector for connecting extension Cat.No 6 548 93
1	6 548 93	Extension for Incara™ Link'On With 1.5 m power cord with Wieland GST18i3 connector ● Black Extension for Link'On Cat.Nos 6 548 91/92 Composition: - 4 x 2P+E sockets - 2 x 15 W USB Type-A + Type-C chargers

Incara™ Link'On

technical characteristics

Using two extendable Incara™ Link'On units together

Cat.Nos 6 548 91/92/93

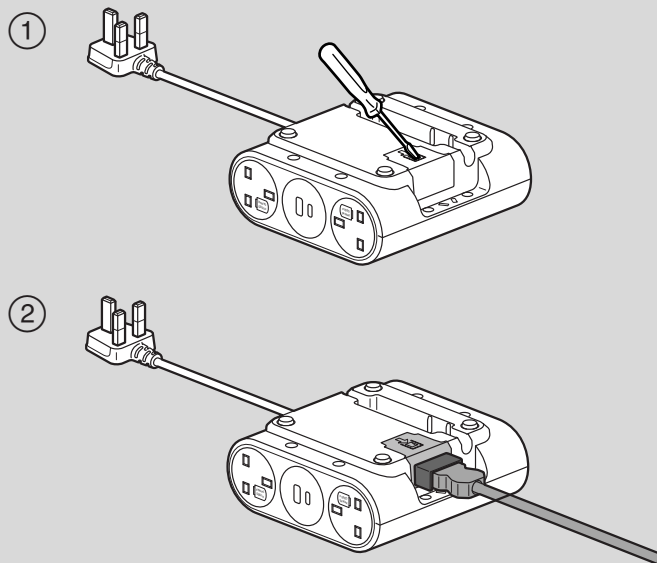

6-socket Incara™ Link'On in a meeting room

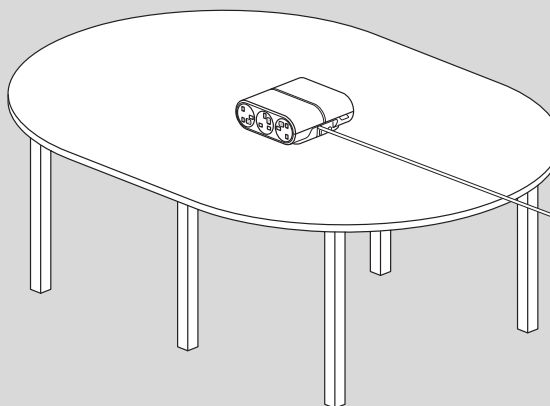

Using two 4-socket Incara™ Link'On units together in a meeting room

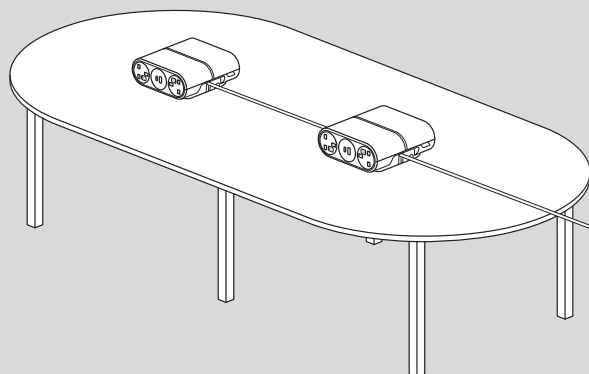

Incara™ Vertebra

for offices and desktops



6 549 92

6 549 90

For securing and running cables vertically from a desk to the floor or for running cables horizontally directly under a desk surface

Pack	Cat.No	Desk Vertebra
1	6 549 92	2 compartments - 120 cm
	6 549 93	Two possible uses: - fixed position with rotation around 2 axes - flexible position with rotation around 4 axes Attached using screws or double-sided adhesive pads (supplied) Ideal for running cables horizontally
		● Grey
		● Black
1	6 549 90	4 compartments - 80 cm
	6 549 91	Vertical Weighted metal base Can be screwed onto the underside of a desk or inserted in a Ø80 mm cut-out
		● Grey
		● Black

Incara™ Vertebra

technical characteristics

Dimensions (mm)

2-compartment Vertebra

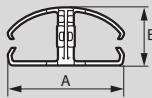

A	54
B	27

Bend radius

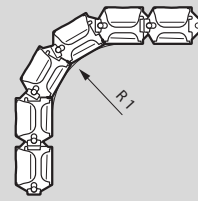

R1 50 min.

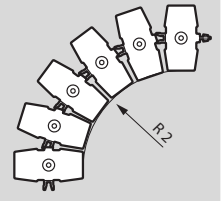

R2 80 min.

4-compartment Vertebra

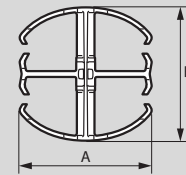

A	54
B	54

Bend radius

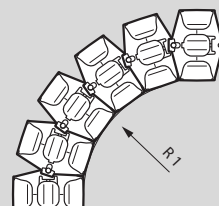

R1 80 min.

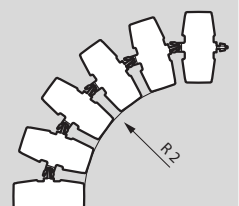

R2 80 min.

2-compartment Vertebra

Fixed position



Flexible position

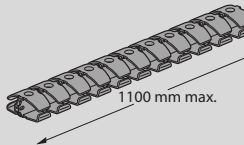

1100 mm max.

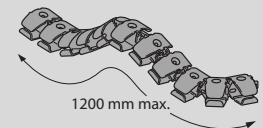

1200 mm max.

Mounting a 2-compartment Vertebra

Using screws Ø3.5 mm max. (not supplied)

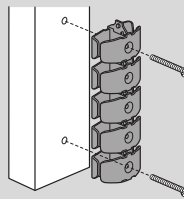

Using double-sided adhesive pads (supplied)

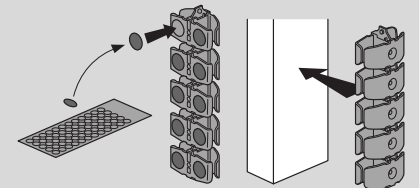

Recommended installation temperature: +15 °C to +25 °C

Mounting a 4-compartment Vertebra

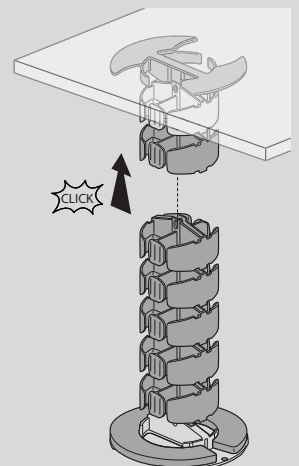
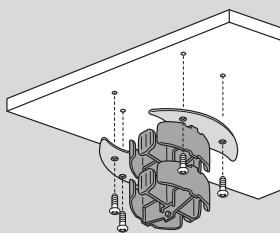





Catalogue number index

Cat.Nos	Page	Pack	Cat.Nos	Page	Pack	Cat.Nos	Page	Pack	Cat.Nos	Page	Pack	Cat.Nos	Page	Pack	Cat.Nos	Page	Pack
0 776 00			6 548 04	41	1	6 548 70	43	1	6 549 24	46	1	6 549 55	39	1	6 550 06	38	1
0 776 38L	40	1	05	41	1	71	43	1	25	46	1	58	43	1	07	38	1
39L	40	1	06	41	1	72	43	1	30	46	1	59	43	1	08	38	1
40L	40	1	07	41	1	73	43	1	31	46	1	60	43	1	12	38	1
41L	40	1	08	41	1	74	43	1	32	46	1	61	43	1	13	38	1
42L	40	1	09	41	1	75	43	1	33	46	1	64	43	1	14	38	1
43L	40	1	10	41	1	91	47	1	34	46	1	65	43	1			
45L	40	1	11	41	1	92	47	1	35	46	1	66	43	1			
46L	40	1	12	41	1	93	47	1	36	46	1	86	38, 39	1			
			14	41	1	6 549 00			37	46	1	87	38, 39	1			
6 547 00			30	41	1	6 549 12	46	1	41	39	1	90	48	1			
6 547 39	38	15	31	41	1	13	46	1	42	39	1	91	48	1			
99	38, 39	1	33	41	1	14	46	1	43	39	1	92	48	1			
6 548 00			34	41	1	15	46	1	50	39	1	93	48	1			
6 548 00	41	1	36	41	1	16	46	1	51	39	1	6 550 00					
01	41	1	37	41	1	17	46	1	52	39	1	6 550 00	38	1			
02	41	1	39	41	1	19	46	1	53	39	1	01	38	1			
03	41	1	67	43	1	21	46	1	54	39	1	02	38	1			



FOLLOW US ON

- @ www.legrandgroup.com
-  youtube.com/user/legrand
-  facebook.com/Legrand
-  twitter.com/Legrand
-  pinterest.com/legrandgroup
-  instagram.com/legrandnews



Head Office
and International Management
87045 Limoges Cedex - France
Tel: +33(0)5 55 06 87 87
Fax: +33(0)5 55 06 74 55